



# EVERYTHING UNDER ONE ROOF



Southwest's leading supplier of metal roofing and cladding products

welcome

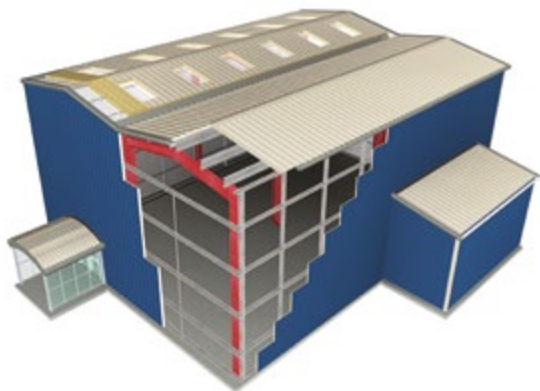

In this brochure you will find information and images of our systems and solutions for a range of construction applications for the agricultural and industrial building sector.

The applications cover secondary structural steelwork, single skin profiles, condensation control, unique ventilation systems, insulated composite panels and twin skin insulated solutions, rainwater management, flashings, fabrications, right down to the last fixing.



The **metal building envelope solution provider** for the **agricultural** and **industrial** markets

A close-up photograph of a blue metal building component, possibly a joint or fastener. A red cap is visible at the top. The background is a blurred industrial setting.

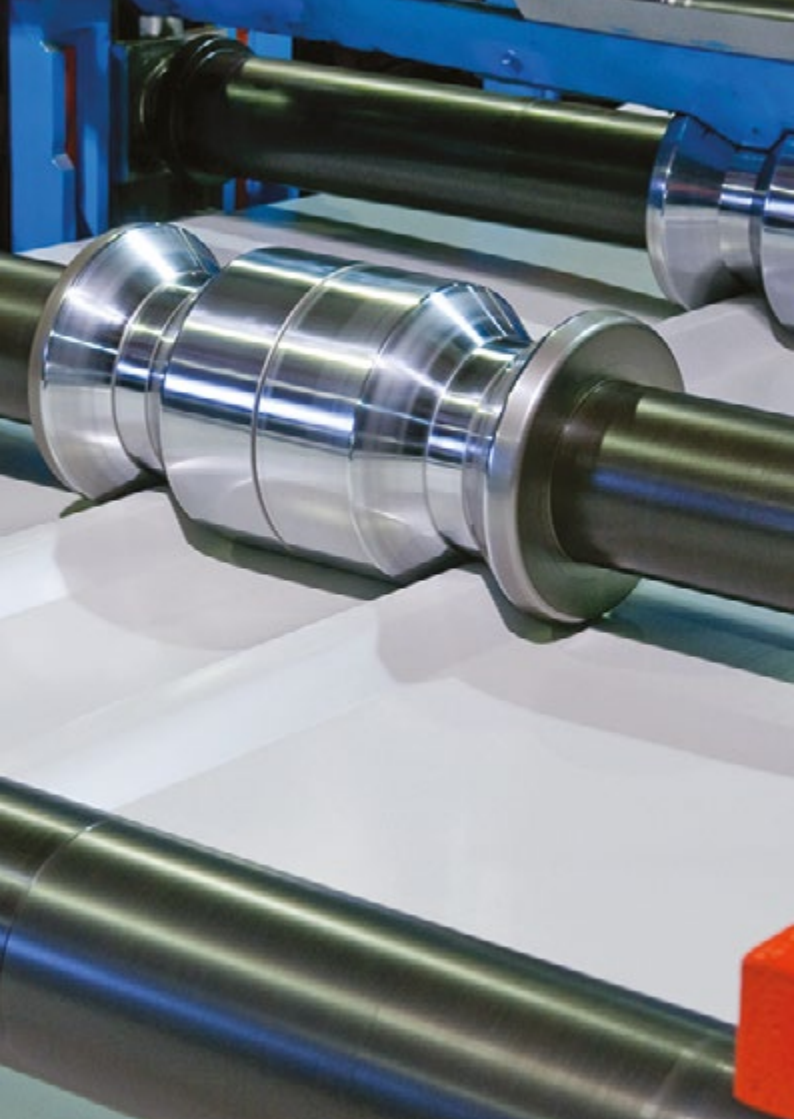

## United Roofing Products

We manufacture, stock or source all the requirements for the agricultural market, specialist contractors, frame builders and end users alike. From the steel frame out we have it all under one roof.

We offer rapid, cost effective, made to measure systems and products to minimise waste and site work to suit any project in the sector.

We have a skilled team with technical support who are happy to discuss and advise you on the requirements for your project of any size.

We are a founding member of the RIDBA organisation and are a very active participant within the association.



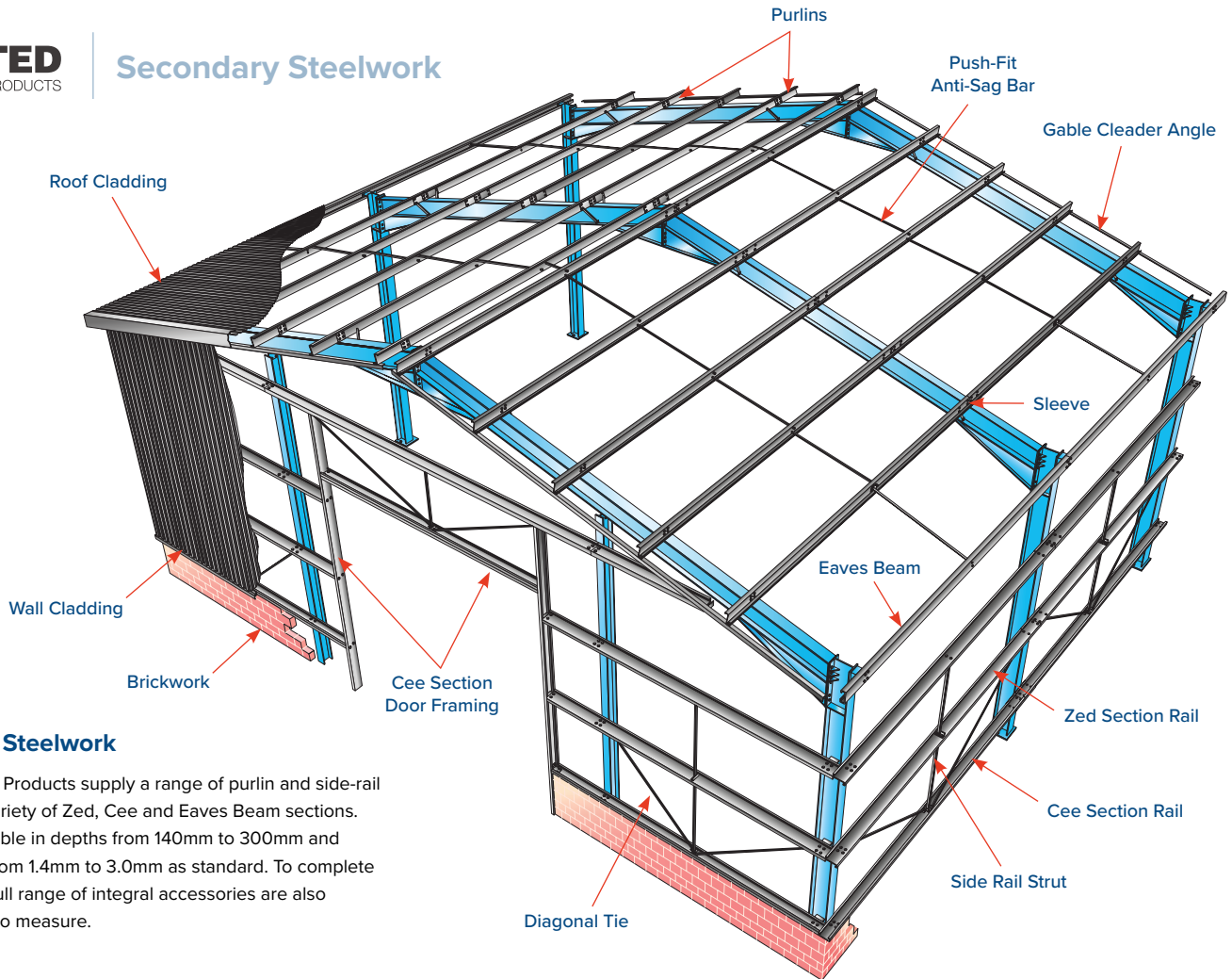

### Secondary Steelwork

United Roofing Products supply a range of purlin and side-rail systems in a variety of Zed, Cee and Eaves Beam sections. They are available in depths from 140mm to 300mm and steel gauges from 1.4mm to 3.0mm as standard. To complete the system, a full range of integral accessories are also manufactured to measure.



We offer **design assistance** for all types of **portal frame** or **roof construction** projects.



Cee Sections



Eaves Beams



Zed Sections



Cee Sections

Our cold rolled building products are manufactured from high tensile S450GD steel with Z275 galvanised finish.

To complement our building envelope solution we offer design assistance for all types of portal frame or construction projects.

Consideration of the cladding system to be utilised is always accounted for at design stage and will be denoted on the project overview.

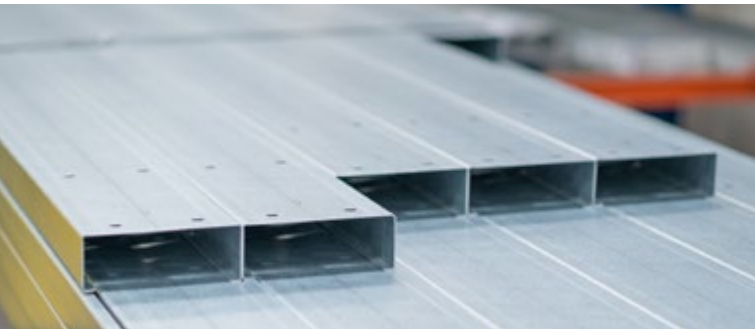



- Assisted design and preliminary take-off service.
- Design software used is to the latest EC3 building codes.
- Conformity assessed to UKCA/CE on standard and non-standard Purchaser Provided CE (PPCE) sections.
- Notching and non-standard hole configurations available on all sections.
- Technical expertise and site visits.
- Our standard cold rolled sections are available in Tekla, Advanced Steel and Strucad for ease of detailing.
- Alternative coatings available for agricultural and corrosive environments.

Mezzanine Secondary Beams and accessories are lipped Cee section profiles, manufactured from pre-galvanised S450 grade steel, with a minimum yield strength of 450N/mm<sup>2</sup>. The decking above the Cee sections helps spread the loads of the floor evenly and varies in thickness depending on the loads. We have a full range of accessories to complement our mezzanine beams, along with design assistance and electronic detailing sheets.





Purlins are manufactured to suit multiple span conditions.

Double span, sleeved or non-continuous sections are utilised to create clear spans of up to 12 metres and achieve optimum construction efficiency.

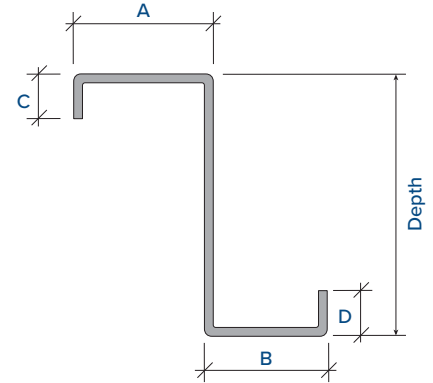

Section Depth	Zed's				Cee's	
	A	B	C	D	E	F
140, 170	60	54	16	20	62	13
200	70	64	16	20	70	15
240	75	67	18	22	74	17
300	95	87	21	25	95	19

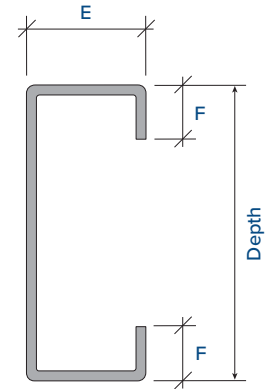



Eaves Beams are available in an optimised section range of 200, 240 and 300mm deep with multiple gauge choices to suit span conditions. All eaves beams can be supplied with a positive or negative angle to the top flange. Negative angles are used in mono-pitch roof construction to offer building stability at the eaves.

Channel sections also range from 140-300mm deep and are used in portal frames as side cladding rails, panel joint rail configurations, door trimmers and mezzanine floor systems. Load tables are available on request.

**200 Eaves Beam Series**

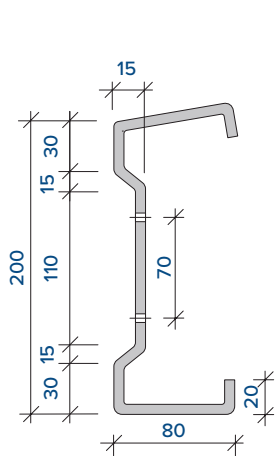

**240 Eaves Beam Series**

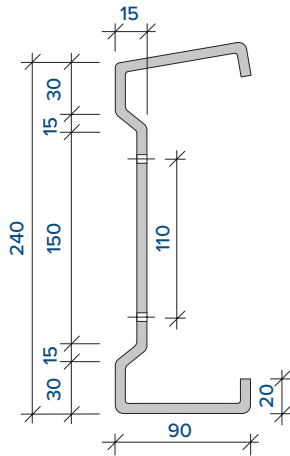

**300 Eaves Beam Series**

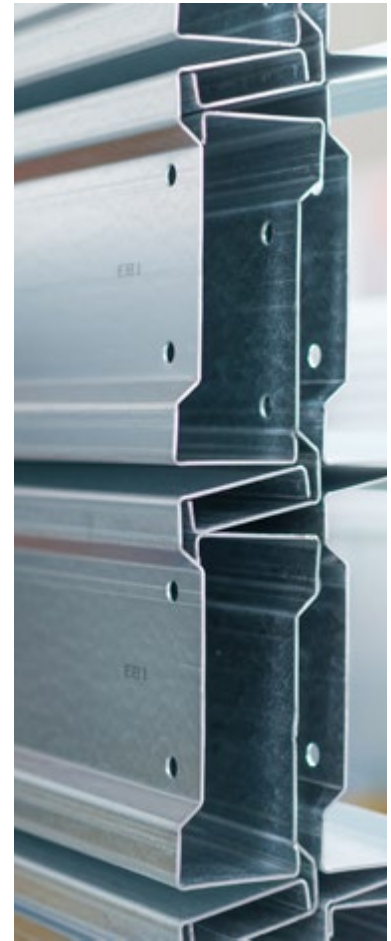
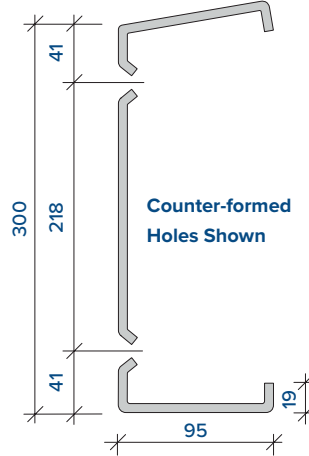

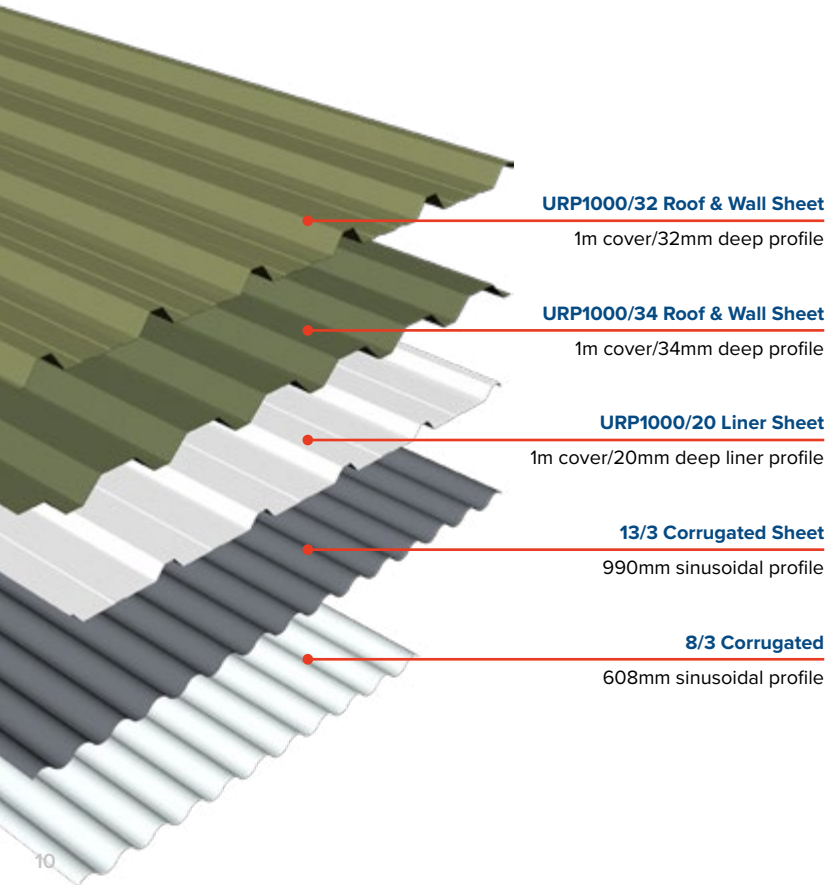

### Single Skin

Our profiled metal sheets are designed for roofing and cladding on industrial, commercial and agricultural buildings.

Profiled sheets are available in 0.4mm, 0.5mm and 0.7mm thick steel in Plastisol and Polyester finishes.

There are 2 deep profiles and a 3 inch corrugated profile for roofing and cladding, along with a shallow liner profile.

We offer a profile identification service for repairs and refurbishment. We can source or manufacture current, obsolete or bespoke profiles to any requirement.

### Daylight Systems

We offer a full range of GRP Roof lights either from standard stock lengths or cut to order. Other custom solutions are available including Polycarbonate, Barrel Vault and Sun Tubes.

### Curving

Box profiles are available crimp curved for curved eaves and crank ridge applications. The 13/3 corrugated profile is available smooth curved for Dutch barns, pig arcs and shepherd huts.

### Accessories

We offer a comprehensive range of fixings, sealants, flashings, in-plane roof lights, gutters, downpipes - all designed to co-ordinate and match each profile.



### Requirements

United Roofing Product's profiled metal sheets are CE and UKCA marked to BS EN 14782:2006. A copy of the Declaration of Performance is available on our web site.

### Steel Specification

The steel is either hot-dip galvanised to BS EN 10346:2015 or Aluzinc coated, then finished in one of our colour coatings. We offer a full range of different finish options (see left) in a variety of colours. Please see our Single Skin Roofing and Cladding brochure or website for more details.

### Finishes

#### Plastisol Leathergrain:

An embossed PVC 200µm thick, factory-applied colour coating, which is tough and scratch resistant with a long lifespan.

#### Polyester:

A mill applied, lower cost coating which is suitable for use on agricultural buildings. A range of alternative coatings available including Polyurethane, PVDF and metallic finishes.

A close-up photograph of metal roof profiles, showing the repeating ridges and valleys of the sheeting. The lighting creates a strong sense of depth and texture, with highlights on the ridges and shadows in the valleys.

# United Roofing Products offer the **best product solutions, certification, warranties** and the **experience and expertise essential to its success.**

- Roof profiles are designed to be supported by steel or timber purlins, with the broad valley resting on the purlin.
- For 0.7mm thick profiles, purlins should be set at 1.8m maximum centres. Consult United Roofing Products for guidance on setting purlins at greater centres.
- Wall profiles should be fixed with their narrow valleys against the side rails.
- All profiles should be isolated from preservative treated timber by using PVC barrier tape applied to the bearing face.
- Supporting steelwork should meet tolerances of BS EN 1090-2:2008 and fixing planes on purlins should be less than L/600 apart (where L is the purlin spacing).
- The minimum roof pitch is 4°.



**URP1000/32 Forward Roof and Wall Sheet:**

32mm deep profile with a 1000mm cover width, suitable for roofing and wall cladding. Available in Plastisol and Polyester finishes as standard.

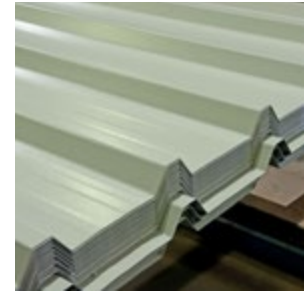
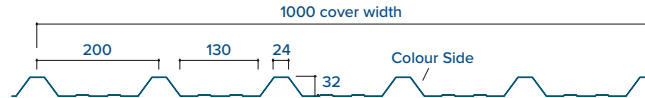

**URP1000/32 Reverse Wall Sheet:**

Colour on opposite side with wide pan off the purlin. Run with adjusted laps to give a seamless finish.



**URP1000/34 Forward Roof and Wall Sheet:**

34mm deep profile with a 1000mm cover width, suitable for roofing and wall cladding. Available in Plastisol and Polyester finishes.

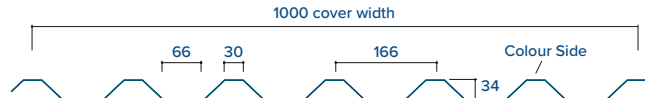

**URP1000/34 Reverse Wall Sheet:**

Colour on opposite side with wide pan off the purlin. Run with adjusted laps to give a seamless finish.

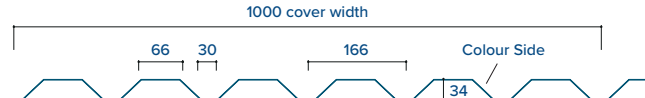

**URP1000/20 Liner Sheet:**

20mm shallow liner profile with a 1000mm cover width, coloured white on one face, for internal lining of walls and roofs, which can be installed above or below the purlins.

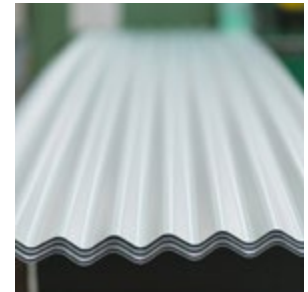
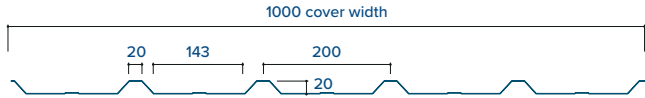

**13/3 Corrugated Sheet:**

A shallow profile corrugated sheet with a 990mm cover width. Available in Plastisol, Polyester and plain galv. Also available in 8/3 (608mm cover) in plain galv.



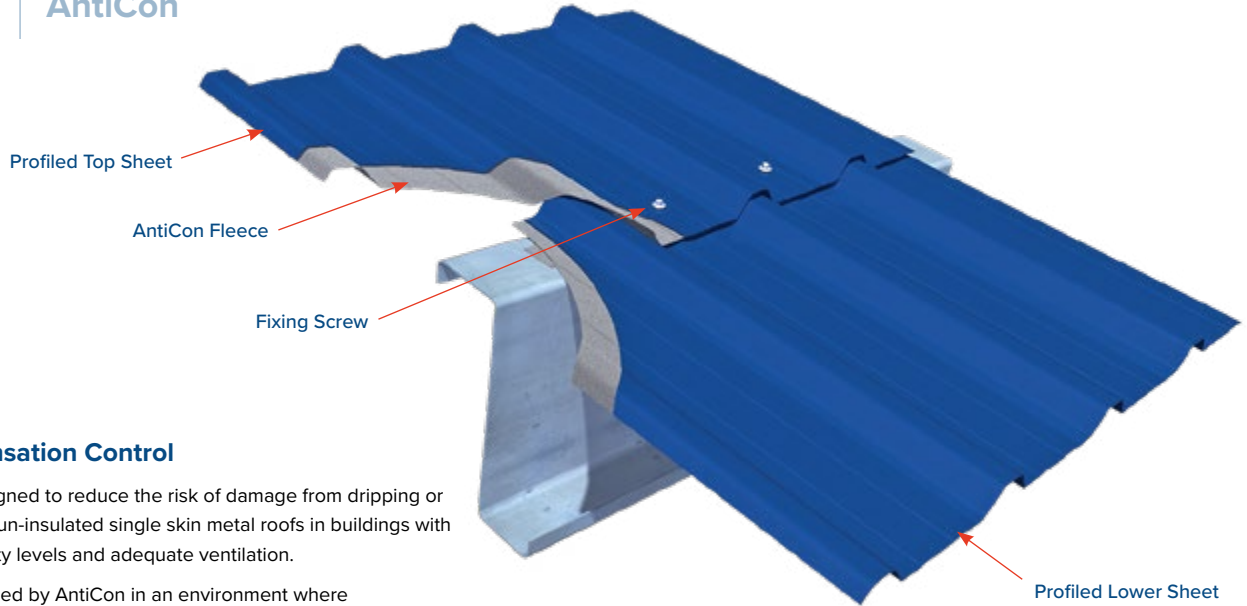

## AntiCon - Condensation Control

AntiCon is a fleece designed to reduce the risk of damage from dripping or running condensate on un-insulated single skin metal roofs in buildings with low to moderate humidity levels and adequate ventilation.

Condensation is controlled by AntiCon in an environment where condensation occurs cyclically. It does not prevent condensation and is damp to the touch when functioning. For the fleece to work properly the building has to be adequately ventilated to allow the material to dry out between the cycles.

AntiCon is suitable for use on roofs at all pitches of 5° and above; more moisture is retained at lower pitches and therefore endlap treatment is required for roofs between a 5 - 10° pitch.

The AntiCon fleece absorbs and holds condensate until it can evaporate, whilst slowing its formation by insulating the sheeting and reduces dripping from the underside of the roof.

## Benefits of AntiCon:

- Holds condensate safely until it evaporates.
- Prevents condensate dripping from the underside of the roof.
- Slows the formation of condensate by insulating the sheeting.
- AntiCon has good resistance to most acids, hydroxides and sulphides and does not support the growth of bacteria or mould.
- If necessary, AntiCon can be cleaned by pressure washing with water.

## Condensation

When warm, moist air within a building comes into contact with cold surfaces there is a risk of condensation as the air cools and is unable to support the same amount of moisture. This commonly occurs on the underside of roofs in un-insulated single-skin metal buildings during the winter, and also on clear nights when night sky radiation substantially lowers the temperature of the roof surface.

Condensation can run down the roof and collect on or within the building fabric where it will cause rust, rot or damage to fittings, or may drip from the roof.

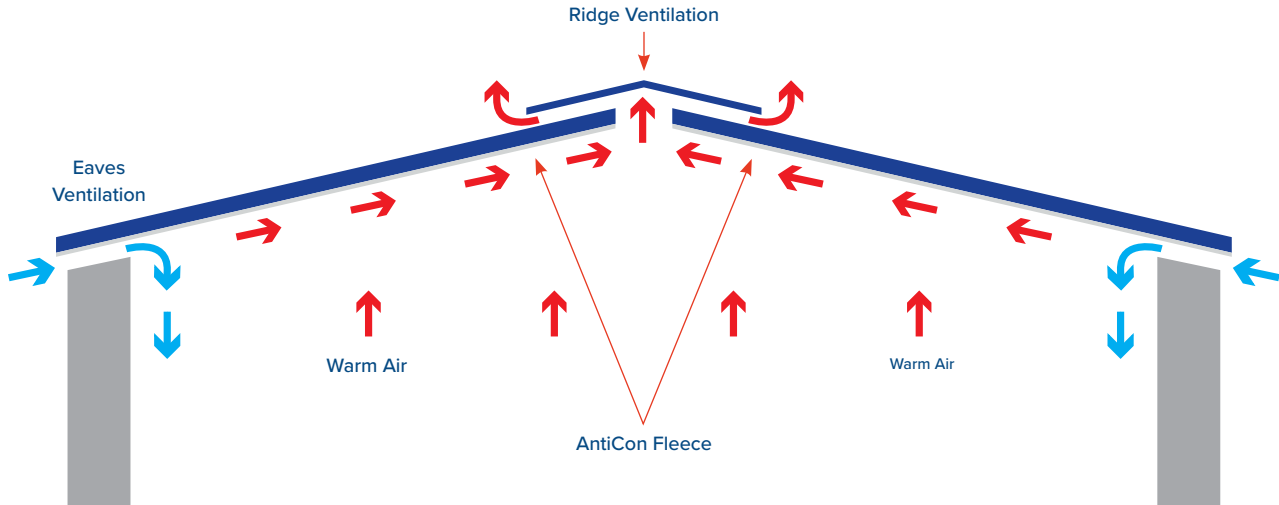

With the **ever increasing focus** on **animal welfare** in agriculture and the **benefits** that **good natural light** and **ventilation** brings to livestock, **United Roofing Products** are focused on **developing systems** that **improve the performance** of **agricultural buildings** in these respects.







Highlight

### Highlight

Highlight is an innovative ventilated wall cladding system that gives high rates of air movement and light transmission.

Highlight fills the building with evenly distributed light and fresh air, providing a natural, sheltered environment which is ideal for livestock.

Bringing all the health benefits of good ventilation and even light without the need for roof lights. Highlight has been proven for use on equine arenas, ménages and milking parlours.

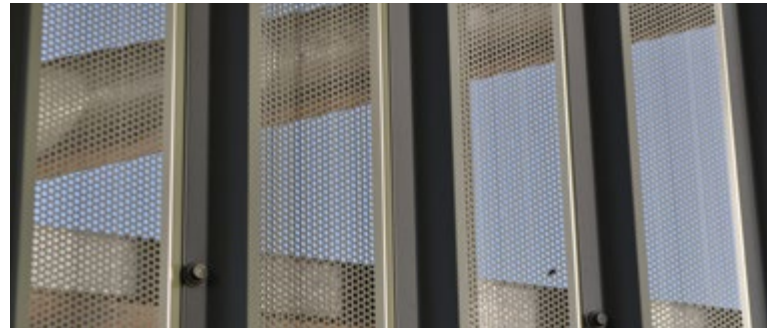



The **improved performance of light and ventilation** has been shown to **reduce vets bills** and **increase the productivity** of the **livestock**.



## Perforated Upstand Ridge

This simple solution consists of a perforated “mini-zed” upstand fixed to the crown of your profiled sheets, to which a ridge capping is then installed. This system provides more protection from the elements where lower levels of airflow are required at the ridge line.

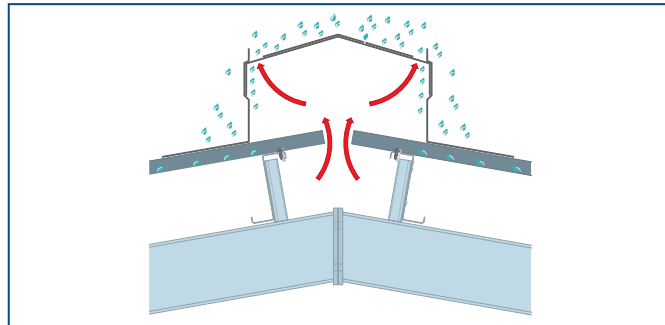
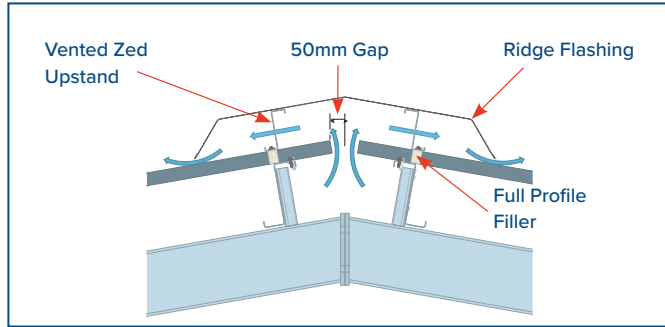

Ventair

## Ventair

Ventair is a box profile wall cladding sheet with louvred slots punched in the wide pan of the profile. This solution provides good protection from the elements whilst allowing airflow in through the walls lending itself for use in exposed elevations.

It is available in a range of colours and finishes cut to length to your specification.



### Twin Skin

United Roofing Products manufactures a range of box profile sheets that can be incorporated into roof and wall twin skin systems. These systems generally comprise of an internal lining sheet, spacing system, insulation and a box profile top sheet. Various depths, insulation types and configurations can be used to achieve the required specification for nearly all applications.

United Roofing Product's unique position as a manufacturer but also major distributor of all metal sheeting and cladding products gives us access to all the technical know-how and the full range of materials to offer solutions to all building envelope scenarios. Including roof lighting, high performing fire wall systems, structural roof decks, acoustic system, aluminium standing seam and secret-fix systems as well as the diversely flexible and cost effective box profile twin skin system.

### Spacing System

The spacing system comprises of a roll formed steel bar and interlocking brackets, which assemble without the requirement for fasteners to form a grid. This method results in a light weight yet very strong, rapidly installed and cost-effective sheeting rail that is elevated to the required height by the bracket. The brackets range in height to create varying depth voids and create solutions for a huge range of various thermal, acoustic and fire resistance criteria. The bracket's narrow base allows the system to be fixed into the valley of the liner or existing roof profile, even those that are sinusoidal and fibre cement. This transfers the weight of the new roof cladding system directly onto the existing substructure of the roof.

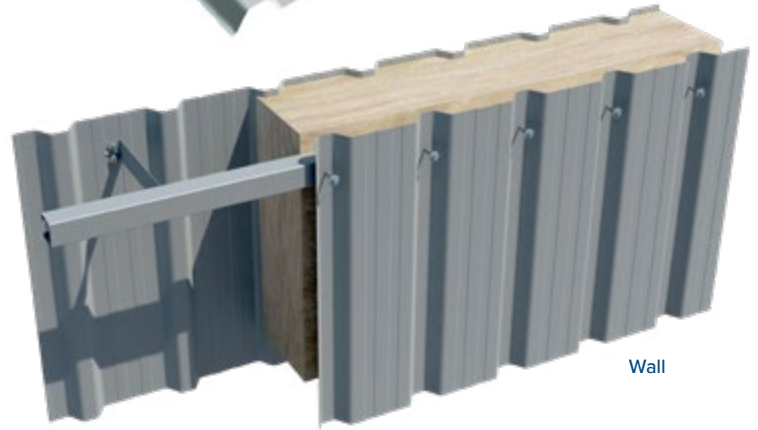
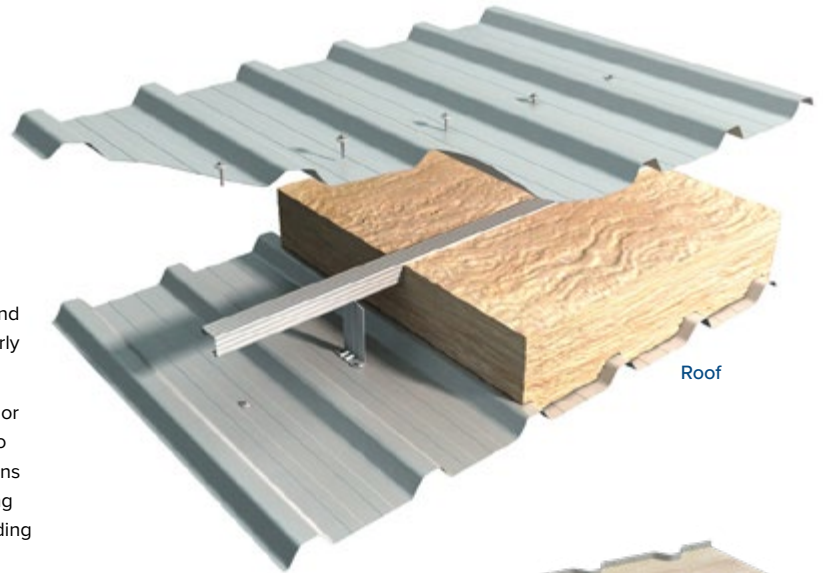





We offer **rapid, cost effective,**  
**made to measure systems** and  
products to **minimise waste** and site  
work to suit **any project**  
in the sector.

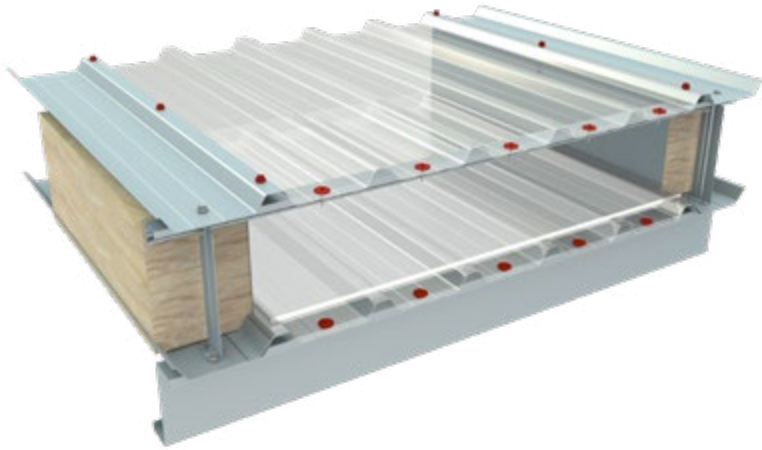

### Twin Skin Daylight Systems

Site assembled in-plane GRP roof lights are available in a range of roof profiles, providing high quality natural daylighting, reducing the need for artificial light, saving energy and helping to reduce the carbon footprint of an industrial building.

Roof lights for twin skin roof systems are site assembled triple skin assemblies in a choice of profile weights and fire ratings, depending upon the application and system guarantee. Roof lights should be used at design roof pitches of 6° and above, giving a finished pitch of at least 4°.

The selection of material weight is dictated by the non-fragility status and applied loadings. The fixing and sealing methods are critical to long term durability and non-fragility.



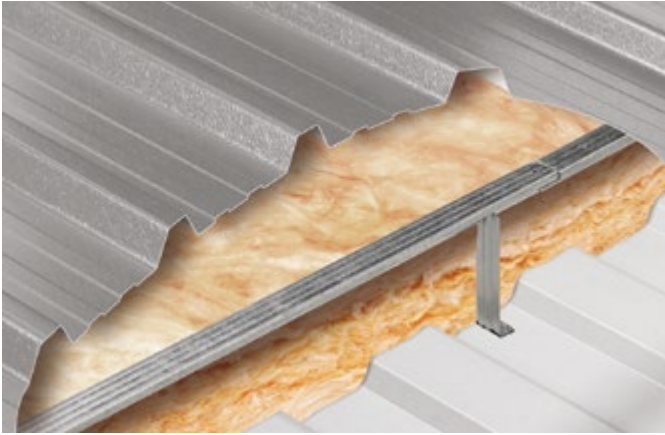

## Over Roof

The spacing system comes into its own in the refurbishment market. Whether you have a leaking roof, wish to increase the thermal and acoustic performance of your roof or wall, or simply improve the aesthetics of your property the spacing system offers quick cost effective solutions.

Simply assemble the bar and bracket to replicate the substructure beneath the existing weather sheet, fix the bar and bracket system using the appropriate fasteners leaving the existing covering in place, insulate if desired and fix the new weather sheet. This solution quickly and cost effectively transforms the appearance and performance of existing buildings. United Roofing Products can produce thermal and acoustic calculations, and offer a range of solutions for aggressive environments.

A full set of fitting instructions and construction details available on request.

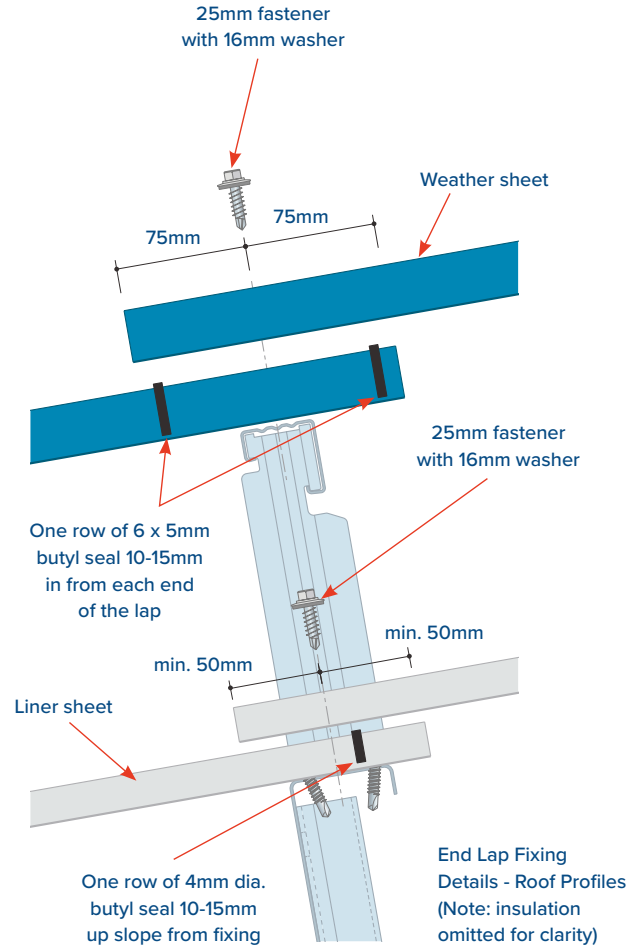



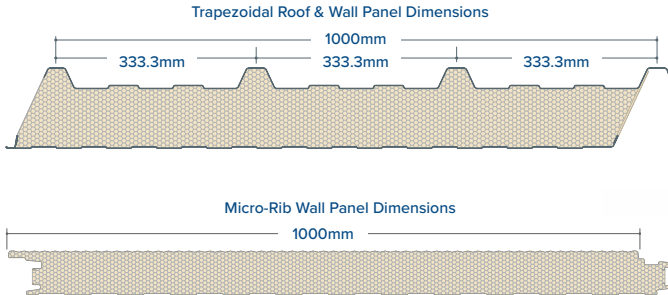

### Insulated Composite Panels

United Roofing Products offer a wide range of LPCB and FM insurance certificates approved foam core and mineral wool panels designed to suit all roof and wall applications. Insulated composite panels consist of a core of high density PIR or mineral wool insulation sandwiched between an external weather sheet and an internal liner sheet.

The composite panel offers an extremely quick and thermally efficient solution for the building envelope. There are significant benefits to using insulated composite panels in regards to making cost and time savings during the schedule of the build. The products go through rigorous testing to ensure their thermal, structural and air leakage performance over the course of their lifetime. You can have peace of mind if you choose insulated composite panels, as the systems come with a 25 year warranty and coating warranties of up to 40 years. You must register the building with the manufacturer on completion of the build.





In regards to fire performance, there are panels available to meet most stipulations that building control specify for either boundary wall or internal partition application. As standard the roof panels come with a high-performance coated trapezoidal box profile weather sheet and a very shallow ribbed Polyester white liner.

There are insulations available in a range of depths from 40mm up to 150mm, with a cover width of 1m, cut to your specified lengths of up to 12m on standard transport (29.3m max length). Short sheets may be subject to a surcharge. There are a wide range of alternative coatings, liner and profiles available on request.

The standard roof panels provide the most cost effective option for vertical cladding. Alternatively there is a perpetually expanding range of architectural wall panel systems, available to suit the growing demand for modern design solutions that won't break your budget. We can provide any technical support and advice on request, including construction details.

- **Self-supporting insulated composite panels for building cladding.**
- **The external face has clean, sharp lines and panels are available in an extensive range of finishes and colours, enabling designers to create modern, visually-engaging buildings.**
- **Attractive and durable, they are used in a wider range of sectors including industrial, retail, office, health, education and leisure.**
- **Suitable for roof pitches as low as 4 degrees.**
- **In plane profile matched factory assembled insulated roof lights available in a range of thermal and non-fragile configurations.**
- **Industry leading thermal and air leakage performance.**
- **Single fix installation saves time and labour on site during construction.**





### Environmental Credentials

We are keen to reduce the impact our business and processes have on the environment and the communities we live in.

While the introduction of sustainable construction methods is a challenge to the whole construction industry, our main raw material – steel – is widely recycled: 85 - 90% of steel from demolition goes for re-use and 40% of steel used in new construction has been recycled.

By using modern machinery and upgrading our facilities we are continually reducing the impact of our products on the environment, and improving their contribution to the long-term performance of buildings.

### Technical Support

We offer free technical support for all our products, including:

- **Technical data sheets**
- **Copies of test certificates**
- **Loading calculation**
- **Design and installation guidance**

Call us on **01884 839302** or email queries to [sales@unitedroofingproducts.com](mailto:sales@unitedroofingproducts.com)

All our product information is available on our website: [www.unitedroofingproducts.com](http://www.unitedroofingproducts.com)

# The metal building envelope solution provider for the agricultural and industrial markets



SCAN ME



© Building Solutions (National) Limited

Issue 2 - 01/2024/SK

Images for illustration purposes only not scope of supply.

The information given in this guide shall be regarded as accurate at the time of going to print and may be subject to change thereafter.

United Roofing Products (a trading division of Building Solutions (National) Limited) reserves the right to alter or delete any product and/or technical specification featured in this guide without prior notice.





**The metal building envelope solution provider  
for the agricultural and industrial markets**

**Single skin profiles • Insulated composite roof and wall panels  
Twin skin systems • Purlins and rails • Condensation control  
Gutters and flashings • Roof lights • Drainage products  
Fixings and sealants • Aluminium products**

**Call us on 01884 839302**



**[sales@unitedroofingproducts.com](mailto:sales@unitedroofingproducts.com) | [www.unitedroofingproducts.com](http://www.unitedroofingproducts.com)**

**United Roofing Products, Unit 4 Lucas Way, Hitchcocks Business Park, Uffculme, Cullompton, Devon EX15 3FA**